





180 ATJ

TECHNICAL DATA SHEET



www.manitou.com

180 ATJ

	180 ATJ
 Working height	18.15 m
Platform height	16.15 m
Articulation height	7.41 m
Outreach	10.62 m
 Jib tilting	+70°/-70°
Basket rotation	+90°/-90°
Turret rotation	355°
 Capacity	230 kg
Number of persons (indoor/outdoor)	2/2
Basket (width and length)	1.80 x 0.80 m
 1. Overall width	2.28 m
2. Overall length	7.64 m
3. Overall height	2.46 m
4. Overall length when folded	5.59 m
5. Overall height when folded	2.66 m
6. Inside turning circle	1.39 m
7. Outside turning circle	3.71 m
8. Turning Radius (basket)	6.89 m
9. Ground clearance	40.5 cm
10. Wheelbase	2.43 m
 Speed of forward movement	7.2 kph
Working speed	0.80 kph
 Maximum slope accessible	33%
Maximum tilt	5° - 9%
 Tyres	18"
Driving wheels	4
Steering/directional wheels	4
 Weight	7550 kg
<small>(varies according to options & standards of the country)</small>	
 Engine	KUBOTA V1505-E3B
Power	35.1 HP
Environmental noise (LwA)	101 dB

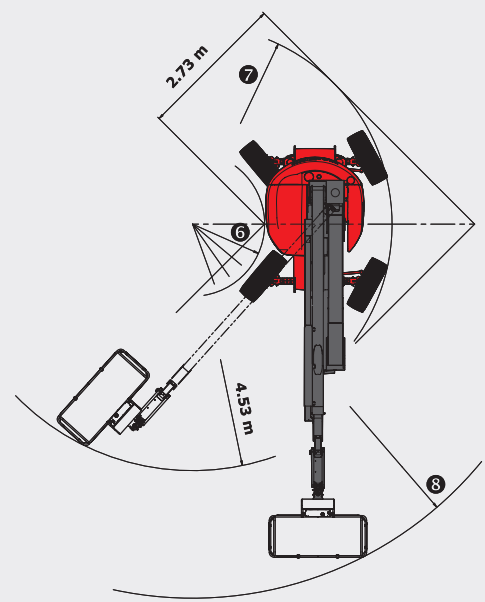
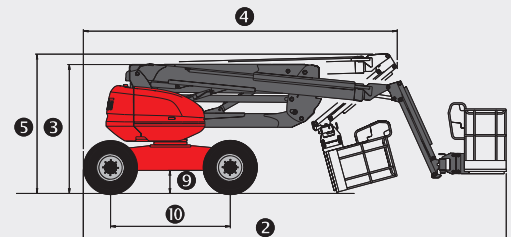
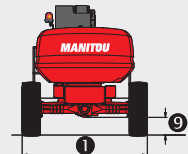
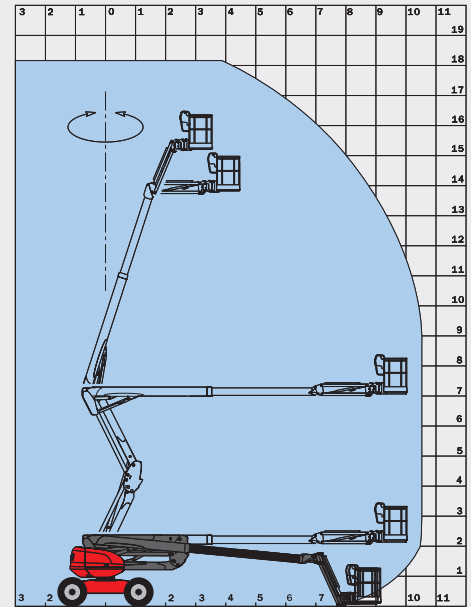

Standard equipment

- Proportional levers
- 4 simultaneous movements
- 4 wheel drive
- 4 wheel steer
- Wheels crab position
- Foam filled tyres
- Differential Lock
- Front axle limited slip differential
- On Board diagnostics
- Hour meter
- Fuel gauge with low level warning
- Tool box
- Protective cover with optional locking
- Horn
- Beacon
- Audible and visual display alarm for excessive slope
- Code protected machine Set Up
- Hooks for sling loading/lifting
- Electric pump
- Predisposition 230V
- Operator Presence Pedal

Optional equipment

- Oscillating axle
- Continuous rotation
- Onboard generator (3.50 kVA)
- 230V power input with differential circuit-breaker
- Predisposition compressed air
- Predisposition of water
- Working light
- Special paint
- Biodegradable oil
- Warning alarm for all movements
- Warning travel alarm
- Catalytic convertor
- Spark arrester and overrun valve
- Anti theft code
- Non marking tyres
- Certificate of verification
- Safety harness
- High capacity battery

This brochure describes versions and configuration options for MANITOU products which may be fitted with different equipment. The equipment described in this brochure may be standard, optional or not available depending on version. MANITOU reserves the right to change the specifications shown and described at any time and without prior warning. The manufacturer is not liable for the specifications given. For more information, contact your MANITOU dealer. Non-contractual document. Product descriptions may differ from actual products. List of specifications is not comprehensive. The logos and visual identity of the company are the property of MANITOU and may not be used without authorisation. All rights reserved. The photos and diagrams contained in this brochure are provided for information only.

MANITOU BF SA - Limited company with board of directors - Share capital: 39,547,824 euros - 857 802 508 RCS Nantes

